



# Construction Description

on

**Chhiring Kharka**

**Community Emergency Clinic**

at

**Chhiringkharka**

**Bakanje VDC, ward 1 & 2**

**Upper Solu, Nepal**

**1. February 2009**

**In international cooperation between:**

**PONA Foundation**

**Himalayan Project Denmark**

**Chhiring Kharka Community Emergency Clinic Construction Committee**

written by **Kurt Lomborg**

**Chairman of Himalayan Project Denmark**

## CHHIRRINGKHARKA COMMUNITY EMERGENCY CLINIC

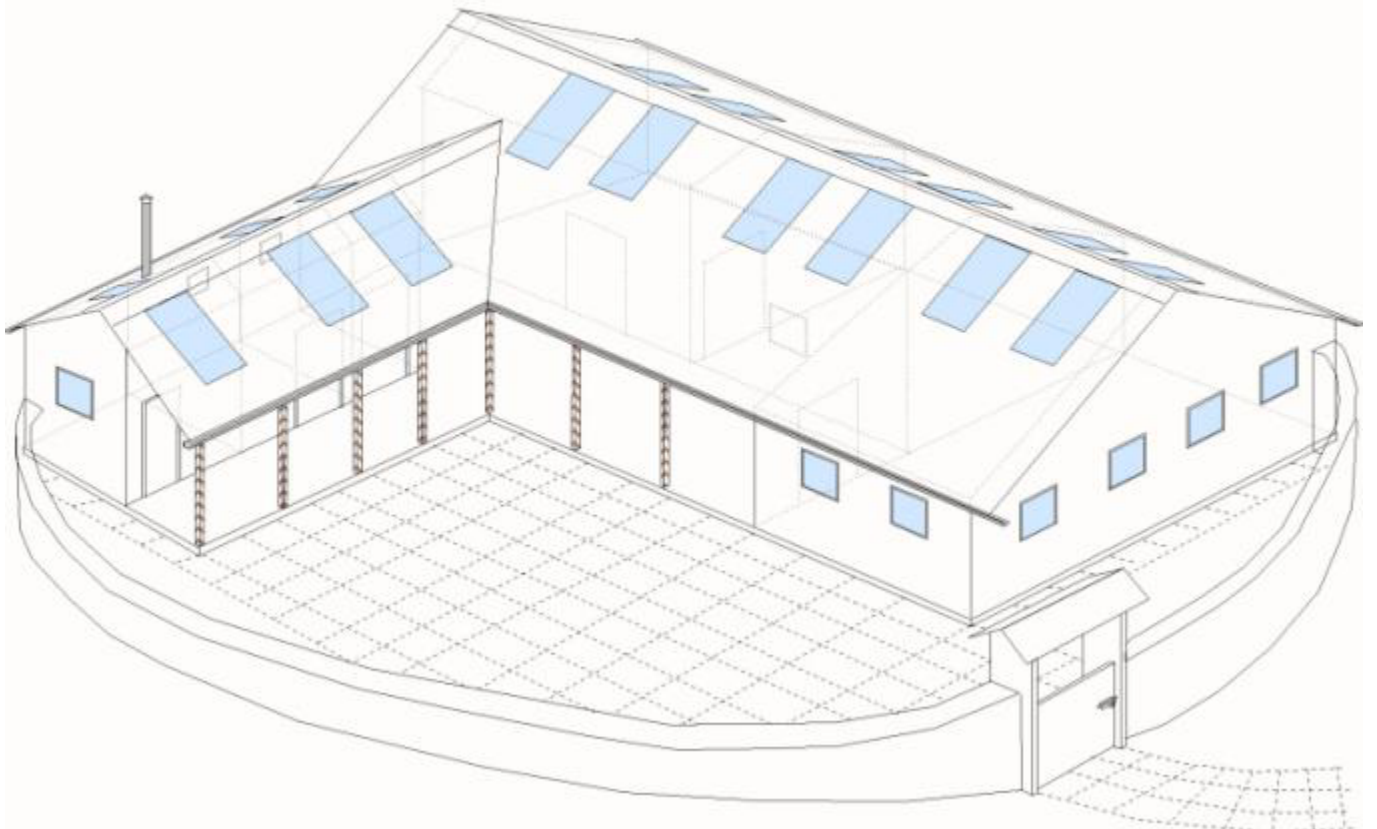

## Forming Committee's and their work:

### **Chhirringkharka Community Emergency**

**Clinic Committee** is already established and in work. This Committee will be the one which shall run the Clinic when it is established, but already now they shall start doing following:

- 1) CCEC-Committee shall **elect** the Construction Committee and the Monitoring Committee, among themselves and among the villagers. But no member of those two committees can take seat in both committees.
- 2) CCEC-Committee shall make **deed** on the land at Napi Office in the name of CCEC.
- 3) CCEC-Committee shall approach and negotiate with **DHO** for approval and about future support and education.
- 4) Shall **select** a group of volunteers who is ready to receive training in First Aid and Emergency Treatment.
- 5) Shall **select** 1-2 married women/men who are ready to receive 18 months of ANM training in Kathmandu.
- 6) Shall open a **Bank Account** in Rastriya Banjiya Bank in Salleri in the name of CCEC and shall start collecting funds for the Foundation which shall run the Clinic.
- 7) CCEC-Committee shall **mobilize** the population of Chhirringkharka, Lole and Patale to secure that they understand the future of the clinic and their personal involvement to make this Clinic sustainable. But also to involve them and inform them about the work and monitoring of the construction process.

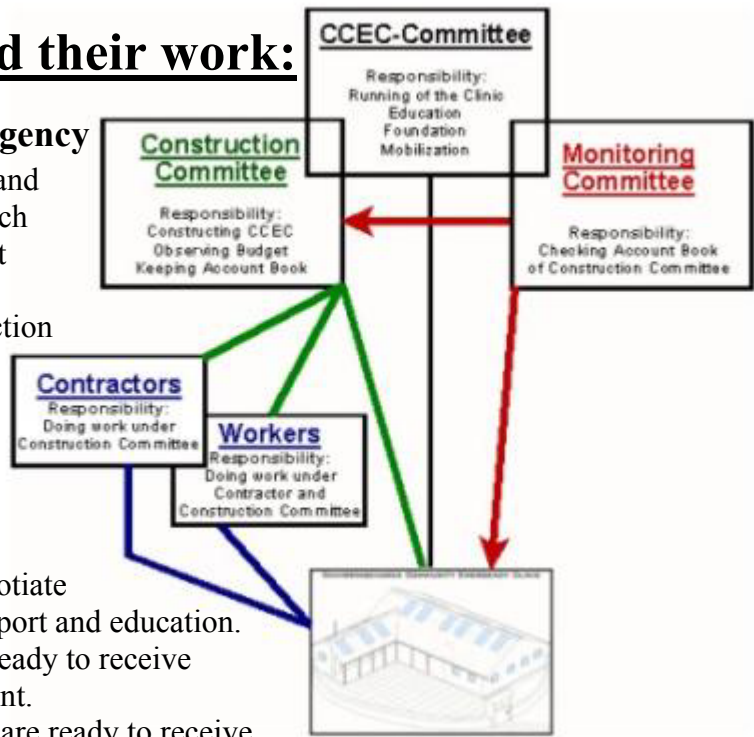

**Construction Committee** shall consist of **5 members** and they shall be responsible for constructing the CCEC in a durable and quality way by following this Construction Description. Construction Committee shall exist until the construction is approved by the Donor and they can hand over the CCEC to CCEC-Committee. The work of this committee shall be:

- 1) Construction Committee shall read and understand all details of the **“Project Description”** and this **“Construction Description”** as they are the final working papers, and the committee shall follow the description carefully and scrupulously. If the committee later finds changes in the description necessary, it shall seek approval for their suggestion by Himalayan Project.
- 2) The Construction Committee shall keep account in the **“Project Account Book”** which is delivered by Himalayan Project at start-up of the project. The responsible **Accountant** shall follow the appended **“Rules of Accounting”** very strictly. The Account Book shall be open for checking at any time on the request of Monitoring Committee and any other villager, and in case of disapproving any detail by those who are monitoring, the Construction Committee shall hold a meeting to make decision on the issue and do Report on it.
- 3) The Construction Committee shall observe the **Budget** carefully and no budget excess will be approved later on by the Donor, but has to be covered solely by the committee and the village. If unforeseen budget excess seems to come up, the committee can try to approach the Donor for approval.
- 4) The committee shall take quotations by **Contractors** and employ the one who can offer the best work for the best price. Or the committee can employ **Workers** to do specified work on man-day basis if it is in clear advantage for the quality of the project, and the Budget will not be exceeded.
- 5) The committee shall **overview** the Contractors and Workers that they are doing the demanded quality of work within the agreed timeframe and that they are observing the demands on dimensions. The committee shall also see to that materials are used conscientious without careless and purposely waste and concealing.
- 6) The committee shall check all purchased **materials**, from the jungle, stone quarry and shops, that they are meeting the number, standard and price which are necessary to do a quality and long lasting construction without making unnecessary expenses on transportation.

**Monitoring Committee** shall consist of **5 members** and they shall be responsible for monitoring and checking the “**Project Account Book**” which shall be managed by Construction Committee on daily basis and with the demanded details and demanded receipts. No member of Monitoring Committee can also be member of Construction Committee or in other ways be tightly related to any member of Construction Committee.

1) In periods with a high level of activities on project site this **monitoring** shall happen on **weekly basis**.

2) Monitoring Committee shall **check** that the purchased materials are delivered on project site in the right numbers and quantities according to the bills. The committee shall also **control** that the performed man-day labor is according to reality.

3) Monitoring Committee shall give date, comment, approval/non-approval and signature on “**Monitoring Record Page**” in the Account Book. In case of non-approval the committee shall **demand** Construction Committee to hold a meeting to take decision and write Record on the issue.

## **BUDGET details:**

It shall be emphasized to Construction Committee and all Contractors that the Budget details in this description are approved by Construction Committee on 14<sup>th</sup> January 2009 with minor amendments, which is annexed by end of this document.

The Construction Committee can give **Contract** to Contractors according to their quotation on the particular work in the **Subprojects** as mentioned below. This Contract cannot exceed the described Budget on the Subproject. If the Contract is lower than the Budget the surplus amount cannot be transferred to other Subprojects without the consent and approval by Himalayan Project.

Procurement of **local** raw materials, like stones and wood, shall be in its own Subproject, which later can be distributed to the other concerned Subprojects. Other materials, which shall be supplied from **outside** shall be within the concerned Subproject and under the responsibility of the Contractor on the concerned Subproject.

No Subproject is allowed exceeding the Budget. In case it shows necessary of well-founded and unforeseen reasons it shall be approved by Himalayan Project before the work can continue.

**Surplus** of Budget on each Subproject belongs to the Donor. The Donor is the only one to decide for which purpose this surplus can be utilized. But if all the construction process is performed in an honest and sufficient way, the Donor shall from Himalayan Project’s side be recommended to utilize the surplus for the purpose of the Clinic, for extra investments or for the “Foundation”.

Some work in this description is excessive in comparison with normal constructions because this construction is the matter of a health facility which is dealing with potential health risks and shall be easy keeping clean without hazards towards the surroundings.

## Overview on Sub-projects:

- A) **Stone- and wood-cutting:** producing the needed quantities, numbers and quality raw materials in stone quarries and in jungle (stone, sand, gravel and wood) - transportation for Project site - stone slates for peti and courtyard
- B) **Leveling the Land:** Cutting part of the big rock - constructing supportive compound wall - moving soil - digging for fundament - digging for septic tank and waste water - building fundament - building septic tanks - leveling the soil around the building and septic tanks to prepare RCC and cement floor
- C) **Cement work:** Final preparations for RCC and cement floor - mounting toilet pan, outlet, waste water outlet - place iron for RCC - pouring concrete of fundament-RCC-reinforcement - mounting iron bar for veranda poles - pouring concrete on whole floor - pouring upper cement ring of septic tanks and waste water tanks - pouring lids for the tanks - inside cement plastering in toilet and bathroom - cement punning on all floors and walls in toilet and bathroom - outside cement plastering on all building walls - peti around building - stone slates on courtyard and access way
- D) **Building Construction:** shaping stones - making window- and door-frames - building the walls - mounting wires for roof support - mounting pipes for cold and hot water - roof beam construction - fixing tin roof and skylight - fixing gutters - making doors and windows - fixing iron grating at windows - building kitchen stove with water heater and set up chimney - mud plastering in kitchen - building wash basin in bathroom - set up of 4 wash basins in kitchen, toilet, examination and delivery room - connecting cold/hot water pipes to taps - prepare for connecting solar water heater - water supply - electricity supply - set up electric wire and accessories
- E) **Furnishing the rooms:** wooden ceiling on walls and roof of main building - wooden wall and door for store room - bench and wooden wall in bathroom - producing furniture: 4 beds, 3 cupboards at bed, delivery couch, examination couch, 1 dentist chair, 1 toilet chair, 1 doctors table, 3 chairs, Cupboard and Glass Cabinet in examination room, Glass Cabinet in delivery room and bench & shelves in kitchen.
- F) **Compound Wall and extras:** compound wall and gate
- G) **Equipment Phase:** Purchasing and Transporting equipments and utensils.
- H) **Education Phase:** Education one ANM and several first aid trainees.
- I) **Administration & Monitoring** by Himalayan Project

## Abbreviations and explanations for Budget Details:

Linear Measures:

feet = f                  inch = "  
length = L:            height = H:            width = W:            thick = T:  
1 foot = 12" = 30,48 cm                  1 inch = 2,54 cm  
1 meter = 3,28 feet = 39,4"  
1 hat = 45,7 cm

Square Measures:

1 foot<sup>2</sup> = 144 inch<sup>2</sup> = 929,03 cm<sup>2</sup> = 0,0929 m<sup>2</sup>                  1 m<sup>2</sup> = 10,76 ft<sup>2</sup>

Cubic Measures:

cubic feet = f<sup>3</sup>                  1 pile = 5 f \* 5 f \* 5 f = 125 f<sup>3</sup> = 3,54 m<sup>3</sup>  
1 m<sup>3</sup> = 35,32 feet<sup>3</sup> = 55 tin                  1 tin = 18 liter

Calculations:

addition = +            subtraction = ÷            multiplication = \*                  division = /  
percent of utilization = ut: %

Abbreviations:

MD = Man Day Labor including Fooding                  IT = Inclusive Transportation

| Subject   | Details  | Unit  | Price/unit           | Amount          |                            |
|---|--|---|----------------------|-----------------|----------------------------|
| <b><u>BUDGET Details on Subprojects:</u></b>                                      |  |   |                      |                 |                            |
| <b><u>A. Stone and wood cutting Including Transportation to Project Site:</u></b> |  |   |                      |                 |                            |
| 1)  | Stones for supportive compound wall: L:55f * H:18f * W:3f = 3.000 f <sup>3</sup> / (125 f <sup>3</sup> * ut:65%)   | 35 pile   | 1.115 Rs             | 39.025 Rs       |                            |
| 2)  | Stones for fundament: L: 230f * H: 3,5f * W: 2,0-1,5f = 1.400 f <sup>3</sup> / (125 f <sup>3</sup> * ut:75%)   | 16 pile   | 1.115 Rs             | 17.840 Rs       |                            |
| 3)  | Stones for 2 septic & 1 waste water tank: (3,14 * 4 <sup>2</sup> )f ÷ (3,14 * 2,5 <sup>2</sup> )f * H: 5,5f = 165 f <sup>3</sup> * 3 / (125 f <sup>3</sup> * ut:90%)   | 4 pile  | 1.115 Rs             | 4.460 Rs        |                            |
| 4)  | Stones for walls<br>Walls: H: 7,5f * L: 75f * W: 1,5f = 850 f <sup>3</sup><br>Walls: H: 10,5f * L: 6,5f * W: 1,5f = 110 f <sup>3</sup><br>Walls: H: 12f * L: 27,5f * W: 1,5f = 500 f <sup>3</sup><br>Gable East & West & 1½ Internal: H: 7,5-14f * L: 24 * W: 1,5 * 3½ pcs = 1.400 f <sup>3</sup><br>Gable South & 3 Internal: H: 7,5-10,5f * L: 7,5f * W: 1,5f * 4 pcs = 100 f <sup>3</sup><br>Reduction for Doors: H: 6,5f * W: 5f * 2pcs + H: 6,5f * 4,5f = ÷ 90 f <sup>3</sup><br>Reduction for Windows: H: 3f * W: 3f * 8 pcs + H: 1f * W: 1f * 3 pcs = ÷ 75 f <sup>3</sup><br>Total cubic of Walls: 2.800 f <sup>3</sup> / (125 f <sup>3</sup> * ut:55%) | 40 pile   | 1.115 Rs             | 44.600 Rs       |                            |
| 5)  | Stones for compound wall:<br>South Side: L: 55f * H: 1&3-5(+3)f * W: 3,0-1,5f = 700 f <sup>3</sup><br>East Side: L: 50f * H: 1&5+3f * W: 3,0-1,5f = 900 f <sup>3</sup><br>Total cubic of Compound Wall: 1.600 f <sup>3</sup> / (125 f <sup>3</sup> * ut:65%)   | 20 pile   | 1.115 Rs             | 22.300 Rs       |                            |
|   |  | <b>TOTAL for Stone:</b>   | <b>115 pile</b>      | <b>1.115 Rs</b> | <b>128.225 Rs</b>          |
| 6)  | Stone Slates for Peti, Courtyard and Acces way:  | <b>TOTAL for Stone Slates:</b> 25f * 40f =                        |                      |                 | <b>1.000 f<sup>2</sup></b> |
| 7)  | Sand for Concrete work:  | RCC & Floor & Tank: 15,5 m <sup>3</sup> * 30 tin/m <sup>3</sup> = | 465 tin              | 70 Rs           | 32.500 Rs                  |
|   | Sand for Cement Plastering:  | 200 m <sup>2</sup> * 8 tin/10 m <sup>2</sup> =                    | 160 tin              | 70 Rs           | 11.200 Rs                  |
| 8)  | Gravel (aggregate 20 mm) for Concrete:   | Fundament & Floor: 12,3 m <sup>3</sup> * 63 tin/m <sup>3</sup> +  | 775 tin              | 30 Rs           | 23.500 Rs                  |
|   |  | <b>Total for Sand &amp; Gravel:</b>                               | <b>67.200 Rs</b>     |                 |                            |
| 7)  | Wood for Beams and Veranda Poles:  | Lumb sum:   |                      | 10.000 Rs       |                            |
| 8)  | Wood for Doors & Windows:  | Lumb sum:   |                      | 17.000 Rs       |                            |
| 9)  | Wood for Wall Ceiling & Top Ceiling in main building:<br>4 Side walls: H: 7,5f * L: 48f = 360 f <sup>2</sup><br>2 Side Walls: H: 10f * L: 26f = 260 f <sup>2</sup><br>Side Wall 6 Gables: H: 7,5-10f * 90f = 800 f <sup>2</sup><br>Top Ceiling 3 rooms including notch for skylight: (L: 21f * W: 11f + L: 12f * W: 26f) * 1,5 = 800 f <sup>2</sup>  | Total wood for ceiling: Lumb sum:                                 | 2.400 f <sup>2</sup> | 15 Rs           | 36.000 Rs                  |
| 10)   | Wood for Furniture:  | Lumb sum:   |                      | 9.000 Rs        |                            |
| 11)   | Wood for Gate:   | Lumb sum:   |                      | 3.000 Rs        |                            |
|   |  | <b>TOTAL for Wood:</b>  | <b>75.000 Rs</b>     |                 |                            |
| <b>A. Stone and wood cutting including transportation to Project Site:</b>        |  | <b>TOTAL:</b>   | <b>295.425 Rs</b>    |                 |                            |

| Subject  | Details   | Unit          | Price/unit    | Amount            |
|--|---|---------------|---------------|-------------------|
| <b><u>B. Levelling the Land:</u> Cutting part of the big rock - constructing supportive compound wall - moving soil - digging for fundament - digging for septic tank and waste water - building fundament - building septic tanks - levelling the soil around the building and septic tanks to prepare RCC and cement floor</b> |   |               |               |                   |
| 1)   | Building Supportive Wall on south side at the border of the land: L: 55f * H: 3+15f * W: 3f = 3.000 f <sup>3</sup>  | 160 MD        | 250 Rs        | 40.000 Rs         |
| 2)   | Moving soil - leveling project site - digging for fundament - digging for 3 tanks<br>Moving and leveling the soil around the building and septic tanks to prepare RCC and cement floor:<br>Lump sum, <b>shall be given to CCEC-Foundation</b> because the work is done by Volunteer Labor by Villagers: |               |               | <b>60.000 Rs</b>  |
| 3)   | Building Fundament: L: 230f * H: 3,5f * W: 2,0-1,5f = 1.400 f <sup>3</sup>  | 60 MD         | 250 Rs        | 15.000 Rs         |
| 4)   | Building 2 Septic Tanks & 1 Waste Water Tank: 500 f <sup>3</sup>  | 24 MD         | 250 Rs        | 6.000 Rs          |
|  |   | <b>TOTAL:</b> | <b>244 MD</b> | <b>250 Rs</b>     |
|  |   |               |               | <b>121.000 Rs</b> |

**C. Cement and Floor work: Final preparations for RCC and cement floor - mounting toilet pan, outlet, waste water outlet - place iron for RCC - pouring concrete of fundament-RCC-reinforcement - mounting iron bars for veranda poles - pouring concrete on whole floor - pouring upper cement ring of septic tanks and waste water tanks - pouring lids for the tanks - inside cement plastering in toilet and bathroom - cement punning on all floors and walls in toilet and bathroom - outside cement plastering on all building walls - peti around building - stone slates on courtyard and access way**

|     |  |   |                |                 |  |
|-----|--|---|----------------|-----------------|--|
| 1a) | Concrete 1:2:4 (cement:sand:gravel): RCC: 12 cm thick (4,75 inch):<br>L: 230f * H: 4,75" * W: 1,5f = 135 f <sup>3</sup> = 3,8 m <sup>3</sup>   | Cement: 6 bags/m <sup>3</sup> * 3,8 m <sup>3</sup> =  | 23 bags        | 2.300 Rs        | 52.900 Rs                                      |
| 1b) | Concrete 1:3:6 : Floor: 10 cm thick (4 inch):<br>Tank rings: 10 cm thick (4 inch): (3,14 * 4 <sup>2</sup> )f ÷ (3,14 * 2,5 <sup>2</sup> )f * H: 1/3f = 10 f <sup>3</sup> * 3 = 30 f <sup>3</sup> + extra = 1,0 m <sup>3</sup><br>Tank Lids 6 pcs: 12 cm thick (4,75 inch):<br>L: 8f * W: 4f * T: 0,4f * 6 pcs = 77 f <sup>3</sup> = 2,2 m <sup>3</sup> | 1.300 f <sup>2</sup> * H: 4" ÷ 135 f <sup>3</sup> = 300 f <sup>3</sup> = 8,5 m <sup>3</sup><br>Cement: 4 bags/m <sup>3</sup> * 11,7 m <sup>3</sup>                                  | 47 bags        | 2.300 Rs        | 108.100 Rs                                     |
| 1c) | Cement Plaster 1:4 (cement:sand): 12,5 mm thick (1/2 inch):<br>Inside Toilet & Bathroom and outside whole Building: 12,5 mm thick (1/2 inch)<br>290 f <sup>2</sup> + 1.850 f <sup>2</sup> = 2.150 f <sup>2</sup> = 200 m <sup>2</sup>  | Cement: 1 bag/9 m <sup>2</sup> * 200 m <sup>2</sup>   | 23 bags        | 2.300 Rs        | 53.000 Rs                                      |
| 1d) | Neat Cement Puning 2:1 (cement:very fine sand): 3 mm thick (0,12 inch):<br>Inside Toilet & Bathroom: 290 f <sup>2</sup> = 27 m <sup>2</sup>  | - Cement: 1 bag/15 m <sup>2</sup>   | 2 bags         | 2.300 Rs        | 4.600 Rs                                       |
|     |  | <b>TOTAL for Cement IT:</b>   | <b>87 bags</b> | <b>2.300 Rs</b> | <b>218.600 Rs</b>                              |
| 2)  | Iron rod for RCC: double 10 mm on all RCC:<br>Iron rod for 3 Tank Rings & 6 Tank Lids: single 8 mm:<br>Iron net for concrete floor and 6 Tank Lids:<br>Iron Bars for Veranda Poles:  | 500 feet = 150 meter: Lumb sum IT:<br>250 feet = 75 meter: Lumb sum IT:<br>200 f <sup>2</sup> + 1.300 f <sup>2</sup> = 140 m <sup>2</sup> : Lumb sum IT:<br>17 pcs * 1 1/2 foot IT: |                |                 | 15.000 Rs<br>5.000 Rs<br>10.000 Rs<br>4.250 Rs |
| 3)  | Toilet pan:  | IT:   | 1 pcs          | 2.000 Rs        | 2.000 Rs                                       |
| 4)  | Outlet tube for toilet: 110 mm heavy quality: 1 pcs * 3 meter (with 30° bend)  | IT:   | 3 m            | 1.000 Rs        | 3.000 Rs                                       |

| Subject  | Details                     | Unit | Price/unit                                      | Amount        |                   |           |
|--|-----------------------------|------|---|---------------|-------------------|-----------|
| Outlet tube for waste water: 90 mm heavy quality:  | 8 pcs x 3 meter             | IT:  | 24 m  | 500 Rs        | 12.000 Rs         |           |
| 90 mm bends same heavy quality:  | 3 * 90° bends + 5 * T-bends | IT:  | 8 pcs   | 300 Rs        | 2.400 Rs          |           |
| <b>TOTAL for Iron and Sanitation IT:</b>   |                             |      |   |               | <b>53.650 Rs</b>  |           |
| 5) Labour on concrete: Final levelling, preparation and mounting work of construction site before concrete work: |                             |      | 6 MD  | 250 Rs        | 1.500 Rs          |           |
| RCC concrete work:   |                             |      | 5 MD / 1 m <sup>3</sup> * 3,8 m <sup>3</sup> =  | 19 MD         | 250 Rs            | 4.750 Rs  |
| Floor concrete work:   |                             |      | 5 MD / 1 m <sup>3</sup> * 8,5 m <sup>3</sup> =  | 43 MD         | 250 Rs            | 10.750 Rs |
| Tank Ring and Tank Lid concrete work:  |                             |      | 6 MD / 1m <sup>3</sup> * 3,2 m <sup>3</sup> =   | 20 MD         | 250 Rs            | 5.000 Rs  |
| 6) Labour on cement plastering in toilet, bathroom and outer walls of whole building:                            |                             |      | 3 MD / 10 m <sup>2</sup> * 200 m <sup>2</sup> = | 60 MD         | 250 Rs            | 15.000 Rs |
| Labour on neat cement puning in toilet and bathroom:   |                             |      | 2 MD / 10 m <sup>2</sup> * 27 m <sup>2</sup> =  | 6 MD          | 250 Rs            | 1.500 Rs  |
| 7) Labour on laying stone slates at south and east gable, courtyard and access way:                              |                             |      | 3 MD / 10 m <sup>2</sup> * 100 m <sup>2</sup> = | 30 MD         | 250 Rs            | 7.500 Rs  |
| <b>TOTAL for Labour:</b>   |                             |      | <b>184 MD</b>                                   | <b>250 Rs</b> | <b>46.000 Rs</b>  |           |
| <b>TOTAL:</b>  |                             |      |   |               | <b>318.250 Rs</b> |           |

### C. Cement and Floor work:

**D. Building Construction:** shaping stones - making window- and door-frames - building the walls - mounting wires for roof support - mounting pipes for cold and hot water - roof beam construction - fixing tin roof and skylight - fixing gutters - making doors and windows - fixing iron grating at windows - building kitchen stove with water heater and set up a chimney - mud plastering in kitchen - building wash basin in bathroom - set up of 4 wash basins in toilet, examination and delivery room - connecting cold/hot water pipes to taps - prepare for connecting solar water heater - water supply - electricity supply - set up electric wire and accessories

|  |   |        |               |                   |           |
|--|---|--------|---------------|-------------------|-----------|
| 1) <b>Bricklayer:</b> shaping the stones and build the walls with mud mortar:                              | 35 MD / 10 m <sup>3</sup> * 80 m <sup>3</sup> (2.800 f <sup>3</sup> ) =   | 280 MD | 250 Rs        | 70.000 Rs         |           |
| Mounting pipes for water during construction:  |   | 5 MD   | 300 Rs        | 1.500 Rs          |           |
| Building Kitchen Stove and mudplastering in kitchen:   |   | 10 MD  | 250 Rs        | 2.500 Rs          |           |
| Building Wash Bassin in Bathroom:  |   | 4 MD   | 250 Rs        | 1.000 Rs          |           |
| Setting up 3 small Wash Bassins in toilet, examination room and delivery room and a bigger one in kitchen: |   | 2 MD   | 250 Rs        | 500 Rs            |           |
| Connecting all water pipes to water taps:  |   | 5 MD   | 300 Rs        | 1.500 Rs          |           |
| 2) <b>Skilled Carpenter:</b> to make 6 door-frames and 10 window-frames:                                   | 5 MD / 10 m <sup>2</sup> * 20 m <sup>2</sup> =                            | 10 MD  | 300 Rs        | 3.000 Rs          |           |
| Carpenter to fix the roof beam construction:   |   | 30 MD  | 300 Rs        | 9.000 Rs          |           |
| Carpenter to make 6 doors and 10 windows in good quality:  | 2 MD / m <sup>2</sup> * 20 m <sup>2</sup> =                               | 40 MD  | 300 Rs        | 12.000 Rs         |           |
| 3) <b>Local Craftsmen:</b> Roof laying:  | 3,5 MD / 10 m <sup>2</sup> * 155 m <sup>2</sup> (1.650 f <sup>2</sup> ) = | 55 MD  | 250 Rs        | 13.750 Rs         |           |
| Fixing Ridge Tin and 2 Roof Joint Tin:   | 1 MD / 25 m * 35 m =  | 2 MD   | 250 Rs        | 500 Rs            |           |
| Build stove, set up chimney and mudplastering in kitchen:  |   | 8 MD   | 250 Rs        | 2.000 Rs          |           |
| Painting:  |   | 6 MD   | 250 Rs        | 1.500 Rs          |           |
| Set up Electricity:  |   | 4 MD   | 250 Rs        | 1.000 Rs          |           |
| <b>TOTAL for Labour:</b>   |   |        | <b>451 MD</b> | <b>119.500 Rs</b> |           |
| 4) <b>Roof Materials:</b>  |   |        |               |                   |           |
| CGI Roof Tinn, 26 G, heavy, 3f * 6f:   |   | IT =   | 36 pcs        | 1.125 Rs          | 40.500 Rs |

| <b>Subject</b>   | <b>Details</b>                                   | <b>Unit</b>  | <b>Price/unit</b> | <b>Amount</b>     |
|--|--|--------------|-------------------|-------------------|
| CGI Roof Tin, 26 G, heavy, <b>3f * 7f:</b>   |  | IT = 31 pcs  | 1.350 Rs          | 41.850 Rs         |
| CGI Roof Tin, 26 G, heavy, <b>3f * 3f:</b>   |  | IT = 46 pcs  | 650 Rs            | 29.900 Rs         |
| Plastic Transparent Sheet, good heavy quality, <b>3f * 6f:</b>                                 |  | IT = 18 pcs  | 1.400 Rs          | 25.200 Rs         |
| Ridge Cover, 26 G, heavy, 1f * 6f:   | (35 m) 100f / 5,3f                               | IT = 20 pcs  | 350 Rs            | 7.000 Rs          |
| Cap Nails:   |  | IT = 8 kg    | 150 Rs            | 1.200 Rs          |
| B Washer:  |  | IT = 10 pack | 30 Rs             | 300 Rs            |
| Gutter formed by Tin Plate, 1f * 6f & holders formed by Iron Rod:                              | (50 m) 150f / 5,3f                               | IT = 30 pcs  | 350 Rs            | 10.500 Rs         |
| <b>TOTAL for Roof Materials:</b>   |  |              |                   | <b>156.450 Rs</b> |
| <b>5) Water supply:</b>  |  |              |                   |                   |
| Plastic pipe 25/32 mm from water source to Water Tank:   | 400 meter in 100 m rolls,                        | IT = 4 rolls | 6.000 Rs          | 24.000 Rs         |
| Plastic Drum Tank 500 l:   |  | IT = 1 pcs   | 2.500 Rs          | 3.500 Rs          |
| Iron pipe 35 mm for Water inlet to building:   |  | IT = 15 m    | 300 Rs            | 4.500 Rs          |
| Iron pipe 35 mm:   | 3 pcs T 20/35mm & 5 pcs 35 mm connectors,        | IT = 8 pcs   | 75 Rs             | 600 Rs            |
| Iron pipe 20 mm for Cold and Hot Water to be distributed in building:                          |  | IT = 60 m    | 125 Rs            | 7.500 Rs          |
| Iron pipe 20 mm:   | 8 pcs T & 5 pcs elbow-joint & 15 pcs connectors, | IT = 34 pcs  | 55 Rs             | 1.700 Rs          |
| Flamingo Insulation Pipe for 20 mm Hot Water Pipe:   |  | IT = 30 m    | 150 Rs            | 4.500 Rs          |
| Water taps with regulator for Hot & Cold Water, good quality & showerhead:                     |  | IT = 7 pcs   | 1.500 Rs          | 10.500 Rs         |
| Small Wash Bassins for Toilet, Examination Room and Delivery Room and a bigger one in kitchen: |  | IT = 4 pcs   | 1.500 Rs          | 6.000 Rs          |
| Build in Water Heater for Kitchen Stove:   |  | IT = 1 pcs   | 7.500 Rs          | 7.500 Rs          |
| <b>TOTAL for Water Supply:</b>   |  |              |                   | <b>70.300 Rs</b>  |
| <b>6) Other Materials:</b>   |  |              |                   |                   |
| Iron Gratings for 10 Windows:  |  | IT = 10 pcs  | 1.250 Rs          | 12.500 Rs         |
| Enamel & Paint:  |  | IT =         |                   | 6.000 Rs          |
| Binding Wire & Iron Wire & Hinges & Door Handles & Nails & outlet gratings:                    |  | IT =         |                   | 8.000 Rs          |
| Glass for Windows & Glass Cabinets:  |  | IT =         |                   | 6.000 Rs          |
| Chimney  |  | IT =         |                   | 2.500 Rs          |
| Electric wire internal and external & Fuse Box & Switch:                                       |  | IT =         |                   | 8.000 Rs          |
| <b>TOTAL for Other Materials:</b>  |  |              |                   | <b>43.000 Rs</b>  |
| <b>TOTAL:</b>  |  |              |                   | <b>389.250 Rs</b> |

#### **D. Building Construction:**

**E. Furnishing the rooms:** wooden ceiling on walls and roof of main building - wooden wall and door for store room - bench and wooden wall in bathroom - producing furniture: 4 beds, 3 cupboards at bed, delivery couch, examination couch, 1 dentist chair, 1 toilet chair, 1 doctors table, 3 chairs, Cupboard and Glass Cabinet in examination room, Glass Cabinet in delivery room and bench & shelves in kitchen.

|   |   |        |        |           |
|---|---|--------|--------|-----------|
| 1) <b>Carpenter:</b> Wooden Ceiling in main building: | 7 MD / 10 m <sup>2</sup> * 225 m <sup>2</sup> (2.400 f <sup>2</sup> ) = | 160 MD | 250 Rs | 40.000 Rs |
| Wooden Wall and Door for Store Room:                  |   | 2 MD   | 250 Rs | 500 Rs    |



| <b>Subject</b>  | <b>Details</b> | <b>Unit</b>          | <b>Price/unit</b>    | <b>Amount</b>        |                         |
|---|----------------|----------------------|----------------------|----------------------|-------------------------|
| Bench and Wooden Wall in Bathroom:  |                | 1 MD                 | 250 Rs               | 250 Rs               |                         |
| Bench and Shelves in Kitchen:   |                | 2 MD                 | 250 Rs               | 500 Rs               |                         |
| Furniture: 4 Beds & 3 Bed Cupboards & 1 Examination Couch & 1 Delivery Couch: |                | 50 MD                | 250 Rs               | 12.500 Rs            |                         |
| Furniture: 1 Doctors Table & 3 Chairs & 1 Toilet Chair:                       |                | 25 MD                | 250 Rs               | 6.250 Rs             |                         |
| Furniture: 2 Glass Cabinets & 1 Cupboard in Examination and Delivery Room:    |                | 15 MD                | 250 Rs               | 3.750 Rs             |                         |
| Furniture: 1 Dentist Chair  |                | 8 MD                 | 250 Rs               | 2.000 Rs             |                         |
| <b>E. Furnishing the rooms:</b>   |                | <b><u>TOTAL:</u></b> | <b><u>263 MD</u></b> | <b><u>250 Rs</u></b> | <b><u>65.750 Rs</u></b> |

---

**F. Compound Wall and extras: compound wall and gate**

|   |   |                      |                     |                      |                         |
|---|---|----------------------|---------------------|----------------------|-------------------------|
| 1) Building Compound Wall on top of Supportive Wall / with Fundament: | 1.600 f <sup>3</sup> (45 m <sup>3</sup> ) * 4 MD/100 f <sup>3</sup> = | 64 MD                | 250 Rs              | 16.000 Rs            |                         |
| Building Gate:  |   | 4 MD                 | 250 Rs              | 1.000 Rs             |                         |
| <b>F. Compound Wall:</b>  |   | <b><u>TOTAL:</u></b> | <b><u>68 MD</u></b> | <b><u>250 Rs</u></b> | <b><u>17.000 Rs</u></b> |

---

## G. Equipment Phase:

From Mr. Bishnu Subedi, who have been involved in several Clinic set-ups we have received following Budget on the supply of equipment on the Emergency and General Clinic:

Currency Rates: 1 USD = 76 NRS / 1 DKR = 13 NRS

| S.No.            | Particulars                         | Qty.  | AMOUNTS        |               |              |
|------------------|-------------------------------------|-------|----------------|---------------|--------------|
|                  |                                     |       | NRS            | DKR           | USD          |
| 01               | Family Planning Services            |       | Free           |               |              |
|                  | - Nilocon White / Others tabs       |       | Free           |               |              |
|                  | -Condoms                            |       | Free           |               |              |
|                  | - Sangini / Depo P.                 |       | Free           |               |              |
| 02               | Materials / Equipments              |       |                |               |              |
|                  | - B/ P Set                          | 1     | 2.000          | 155           | 26           |
|                  | - Dental Instruments (set)          | 1 Set | 12.000         | 925           | 158          |
|                  | - hight machine                     | 1     | 800            | 60            | 10           |
|                  | -Apron/ Towel/ bucket/Dust bins etc | 1     | 10.000         | 770           | 132          |
|                  | - Child Delivery bed (imported)     | 1     | 130.000        | 10.000        | 1.710        |
|                  | - Delivery kit set                  | 5     | 5.000          | 385           | 66           |
|                  | - Mattress for examination Couch    | 1     | 10.000         | 770           | 132          |
|                  | - Other isnruments (misc.)          | 1     | 20.000         | 1.540         | 264          |
| 03               | Mother Child Healthcare             |       |                |               |              |
|                  | - Child weiging. Machine + Adults   | 2     | 9.000          | 695           | 118          |
|                  | - FHS Machine                       | 1     | 5.000          | 735           | 66           |
|                  | - Charts, Liflets, Poster           | -     | 2.000          | 155           | 26           |
| 04               | Bedroom                             |       |                |               |              |
|                  | Mattress, bedcover, pillow          | 4 set | 15.000         | 1.155         | 197          |
| 05               | Immunization / Vaccination          | 1 set | 500            | 40            | 7            |
| 06               | Surgery and Dressing Unit           |       |                |               |              |
|                  | - Dressing Equipment ( Minor)       | 1 set | 4.000          | 310           | 53           |
|                  | - Surgery instruments (Minor)       | 1 set | 5.500          | 425           | 72           |
|                  | - Autoclave Machine 1 Kg capacity   | 1 set | 15.000         | 1.155         | 197          |
|                  | - Pad and bandaging Materials       | -     | 7.000          | 540           | 92           |
| 07               | Office decoration Materials/ Others | -     | 7.000          | 540           | 92           |
|                  | Prescriptions +other stationeries   |       | 10.000         | 770           | 132          |
|                  |                                     |       | <b>269.800</b> | <b>21.125</b> | <b>3.550</b> |
| 08               | Transportation                      |       |                |               |              |
|                  | Kathmandu-Jiri                      |       | 8.000          | 615           | 105          |
|                  | Jiri-Chhiringkharka                 |       | 20.000         | 1.540         | 264          |
|                  |                                     |       | <b>297.800</b> | <b>23.280</b> | <b>3.919</b> |
| TOTAL (rounded): |                                     |       | <b>300.000</b> | <b>23.250</b> | <b>4.000</b> |

## H. Educational Phase:

| Particulars  | NRS            | DKR          | USD          |
|--|----------------|--------------|--------------|
| One married woman for Auxillary Nurse Midwife training in KTM: |                |              |              |
| 140.000 NRS - from which Rotary Club of Kathmandu pay 50%      | 70.000         | 5.400        | 925          |
| 3-6 young people take First Aid training at Phaplu Hospital    |                |              |              |
|  | 30.000         | 2.300        | 395          |
| <b>TOTAL (rounded):</b>  | <b>100.000</b> | <b>7.700</b> | <b>1.320</b> |

| <b>Construction BUDGET SUMMARY:</b> |  | 1 DKR = NPR 13,5 | 1 USD = NPR 76,0 |                |                 |
|-------------------------------------|--|------------------|------------------|----------------|-----------------|
|                                     |  |                  | Nepalese Rupees  | Danish Kroner  | American Dollar |
| A.                                  | Stone and wood cutting incl. Transportation to Project Site: |                  | 295.425          | 21.883         | 3.887           |
| B.                                  | Leveling and preparing the land:                             |                  | 121.000          | 8.963          | 1.592           |
| C.                                  | Cement and Floor work:                                       |                  | 318.250          | 23.574         | 4.188           |
| D.                                  | Building Construction:                                       |                  | 389.250          | 28.833         | 5.122           |
| E.                                  | Furnishing the Rooms:  |                  | 65.750           | 4.870          | 865             |
| F.                                  | Compound Wall and extras:                                    |                  | 17.000           | 1.259          | 224             |
| G.                                  | Equipment Phase:   |                  | 300.000          | 22.222         | 3.947           |
| H.                                  | Education Phase:   |                  | 100.000          | 7.407          | 1.316           |
|                                     |  | <b>SUBTOTAL:</b> | <b>1.606.675</b> | <b>119.013</b> | <b>21.140</b>   |
| I.                                  | Administration and Monitoring 15% for Himalayan Project:     |                  | 241.001          | 17.852         | 3.171           |
|                                     |  | <b>TOTAL:</b>    | <b>1.847.676</b> | <b>136.865</b> | <b>24.312</b>   |

# PROJECT DETAILS:

## A. Stone and wood:

Monsoon period shall be avoided for construction as everything will take more time, and rain might harm some construction processes. Therefore the winter and early spring should be utilized for cutting stones and wood, and to purchase and transport materials, which shall be bought from outside.

As Himalayan Project has promised that the project will run the villagers of Chhiringkharka can start this process as long as they can pay themselves for the time being, until a Donor has accepted to go into the project and funds will arrive.

But it must be emphasized that no funds can be transferred before the CCEC-Committee has done their initial work **1)** making deed on the land, **2)** obtaining approval by DHO, **3)** opening Bank Account in the name of CCEC, and **4)** call for village meeting to inform all inhabitants of ward 1 & 2 about the details of this project.

## B. Levelling the Land:

Also this process should be started as soon as possible, preferable during the winter, when weather permits. But the **supportive wall** at the southern border of the project site has to be build before the leveling of land can be efficient. Again here the constructor should start as soon as possible with the expectations to be paid later when Donor has approved the project and funds arrive. Consider how far iron poles shall be fastened in cement already now for clothes-posts to dry and sun-disinfect beddings.

According to agreement with the ad hoc construction Committee in autumn 2008, the work on preparing the project site shall be done by **volunteer laborers** from the village. But nevertheless it is figuring in the budget because the budget amount will then be entered in the **“Foundation of CCEC”** for running of the clinic. This preparatory work, which shall be done by volunteer labor is **moving soil** from upper to lower part, **digging** for fundament and septic tanks and finally **filling** soil around fundament and tanks to make it ready for cement works. It is important that the soil which is moved will be **stamped** and **rammed** so it will not sink in future.

Although this part of the project has been changed since the former donor of land did run from his promises and Da Sarki Sherpa took over as a donor of land, the budget shall not be changed, as long as the premises that the mentioned work shall be done as volunteer labor, to let the surplus go into the Foundation of the Emergency Clinic. It seems obvious, that the new land is much easier to work with, as it is less steep and there isn't any big rock to deal with.

Attention shall be paid to the location of the building, as there shall be space for **two toilet septic tanks** and **one waste water tank** on the west side of the building. The size of the land in east-west direction is a little small, so it could create some problems to find space for this. It should be considered asking the neighbour for donating this small piece of extra land.

The reason to build **3 tanks** is that a clinic is dealing with infectious materials which shouldn't have any access to the surface to create a risk for humans and animals. Furthermore it shall be expected that there will be a high consumption of water for keeping the patients and site clean. Therefore all waste water shall seep into the ground. And therefore the walls of the tanks shall be built as dry walls in a quite open way. In that case the walls of the tanks can only be strong when they are built in a **circular** way. As a lot of water will seep into the ground from waste water tank, there shall be some **distance** between septic tanks and waste water tanks - as much distance as the land permits.

The **fundament** shall be well build and strong and the upper surface shall be completely even and smooth to make a proper base for the RCC.

## C. Cement and Floor work:

This work must be done well before monsoon.

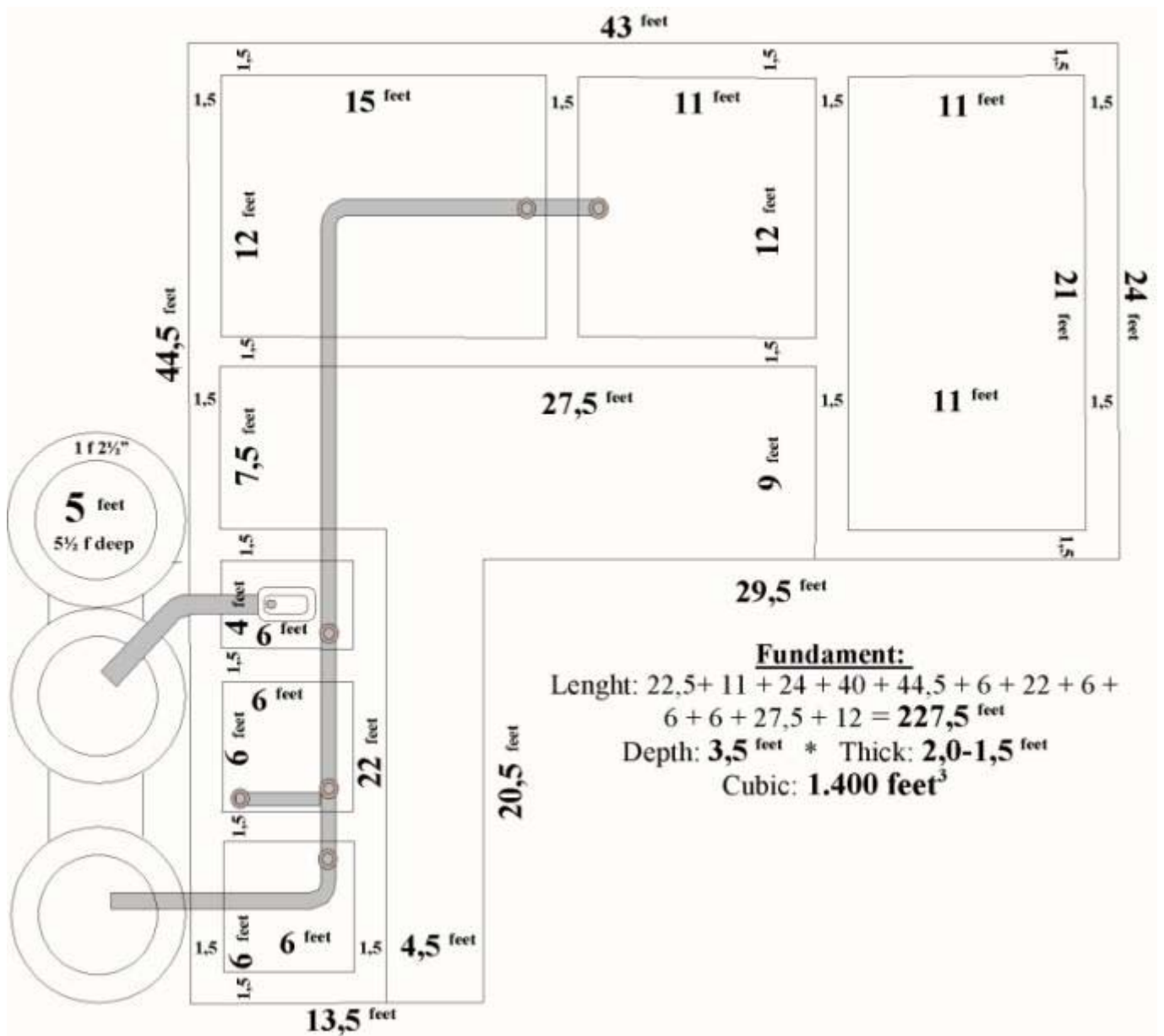

Before the cement work on RCC and floor is initiated, it is very important that the construction site is very **well prepared**. Both fundament and floor shall be prepared at the same time, so all the concrete work can be done within few days so fundament and floor will be constructed in one piece.

**Outlet for waste water** shall be done in the 90 mm water pipe heavy quality which shall be connected by melting together in a quality way, because when the floor is done the tubes will never be reachable again. The tube shall have a completely even inclination on 5 millimeter/foot, so water can run out quickly and there will be no small pools of water remaining in the tube. Also the **downpipes** from wash basins shall be done in 90 mm for possible later access to the inner of the tube.

**Toilet pan** shall be placed on its exact position. Remember that a 12, 5 + 3 millimeter thick layer of cement plastering and punning will be added to the floor later on. **Outlet tube from toilet** shall be done in 110 mm water pipe heavy quality, and it shall have a very steep inclination - at least 3 inch/foot. Right outside the building a new tube shall divert for one of the septic tanks. The two tubes shall be connected by a socket so the tube for the tank can be turned for the other tank from time to time.

It is very important that the **top of the fundament** is leveled carefully so gaps are filled in with mud mortar, and no stones are rising up to make the thickness of the RCC uneven.

The **soil** which shall support the floors shall be **leveled** so it is completely even and smooth (after the outlet tubes are brought on exact place). If the soil is too lumpy, it shall be leveled with gravel. The level of the floor soiling shall be 2-3 cm higher than the top of the fundament. There shall be a slight **inclination** on all floors for easy outlet of cleansing water and it will be easier and more convenient to prepare this inclination on the supportive soil, that doing it later while pouring the concrete. The inclination in toilet and bathroom shall be from door towards the toilet pan or shower outlet and the

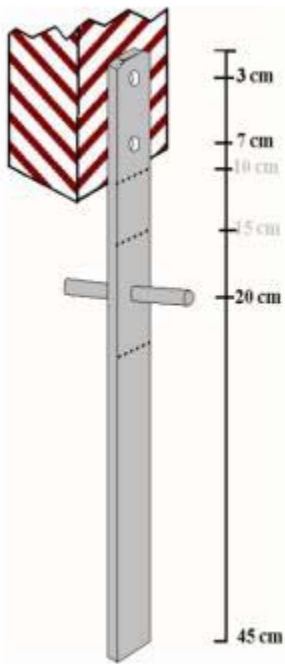

slope in these two rooms shall be quite steep. The inclination in all other rooms shall be from backside of the rooms towards the door, and the slope shall be very less - something like 2 millimeter/foot. The inclination of both verandas shall be outwards to the courtyard. with a little more slope than in the rooms.

Before starting pouring the concrete, **shuttering** shall be set up along all edges of fundament and floor in such a way that the height of the shuttering shall be exactly the height of the RCC and floor to make the measuring of the height of the poured concrete more accurate and easy. The **RCC** shall be like a frame **exactly 12 cm** in thickness everywhere in breadth and in length. And the **floor** shall be **9-10 cm** in thickness everywhere.

Place the **Iron Bar** supporters for the veranda poles by hammering them down in the soil on the exact place where the back side of the veranda poles later shall be situated. The height of the iron bars shall be so that they will support the lower 10 cm of the veranda pole and leaving 5 cm free space under this pole. The transverse peg shall be situated in the middle of the concrete floor. Also put **Iron Anchors** in the fundament for anchoring the doorframes (which shall have no bottom frame). And also put anchors for the wooden wall at Store Room. And the same with the wooden wall in

Bathroom. You might consider to make the anchors for the doors shorter, as they shall only be placed in the RCC which is only 12,5 cm thick.

All RCC fundament **iron enforcements** shall be readymade with cutting and bends. There shall be double iron enforcement in fundament. And the **Iron Net** for the floor shall be adjusted for the exact site with cuttings and other adjustments. When it is readymade it shall be put aside in an orderly way ready to be put back after basic pouring.

Make sure that all **materials** like cement, sand, gravel and water is ready for all the RCC and floor pouring and make sure that enough **space** is available for mixing the concrete. And make sure that enough **people** are available to make the mixing and pouring possible within few days so the whole work can be done in one piece. Each layer of concrete can be allowed to dry a little but it shall not be allowed to harden before the next is added otherwise it will not be bound together but will have weak points. And prepare the appropriate **measuring tins** so the concrete mix will be exactly as prescribed: **A)** for RCC it shall be: **1 cement : 2 sand : 4 gravel** - and **B)** for floor it shall be: **1 cement : 3 sand : 6 gravel**.

Start with **pouring** a layer of concrete all over the surface, 5 cm thick above fundament and 3 cm thick above floor soil. As soon as it is dry enough to walk on, the readymade iron enforcements shall be brought on place. Then the final layer of concrete can be poured on, before the under layer is hardened. To prevent that the gravel shall make the surface of the floor to rough and uneven it shall be vibrated and glittered on the final surface, or even better a final layer of cement:sand mix shall be swiped over the whole surface before the under layer is hardened. This shall not be done on toilet and bathroom floor as a 12,5 + 3 millimeter layer of cement plaster will be added later.

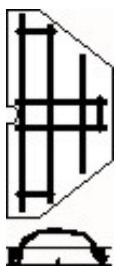

To make sure that the **tanks** shall not collapse in the top they shall have an upper ring of concrete. And even the two septic tanks shall be connected.

The **tank lids** can be poured in a wooden form with plastic lining. The iron enforcement can be done with iron rods or with iron net. The handles done by iron rod shall

be connected to the iron enforcements.

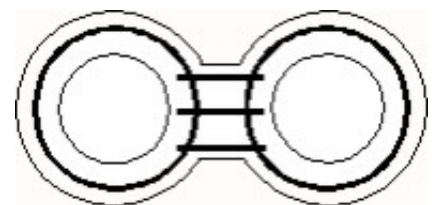

Now the cement workers can relax until the bricklayers and carpenters have completed their work on the building, then they again have to work with the **cement plastering**. In the Toilet and Bathroom they shall take special attention that the plastering is done in a way

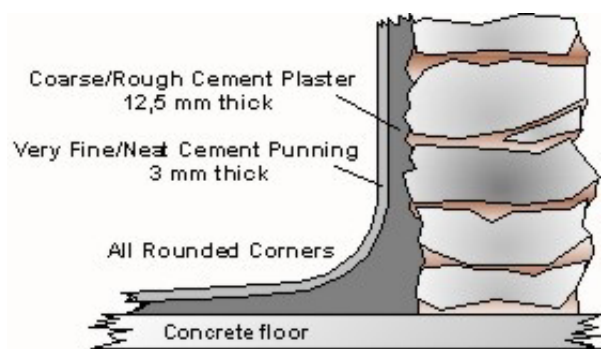

that will make it easy to keep clean. First a 12,5 millimeter thick layer of **1 cement : 4 sand** shall be plastered all over the floor and all the walls from bottom to top. And remember that all corners shall be strongly rounded. Finally these surfaces shall be **punned** with a thin layer (3 mm) of **2 cement : 1 very fine sand**. The sand has to be extremely fine; otherwise it is better to use only cement for punning.

Likewise all **angles** between floor and wall in all rooms (except kitchen) shall have a cement rounded plaster starting 5-10 cm from the wall and stretching 5-10 cm up from the floor. And finally a thin layer of neat cement punning shall be added. This shall be done to make cleaning of the floors more efficient and easy. Therefore the wall ceilings shall not reach the floor but start 7-8 cm above.

Later when the work on project site is almost completed **stone slates** shall be laid as a **peti** on all south and east sides. It shall be laid in 1 cement : 5 sand : 2 gravel just to keep it on place. The stone slates shall be almost in level with the veranda floor - not more than 2 cm below, so wheel chairs will not face problems to roll over the edge. When the peti is laid the rest of the courtyard shall be covered with stone slates in same level. The stone slates shall also cover the access way at least 5-10 meter beyond the gate.

### D. Building Construction:

**Window Frames** shall be 3 x 3 feet. On east wall of Bedroom 4 windows and south wall 2 windows. On south wall of Delivery Room 1 window with matted glass. On South wall of Kitchen 1 window. The 2 ventilation window frames of Toilet and Bathroom shall only be  $1\frac{1}{2}$  x  $1\frac{1}{2}$  foot.



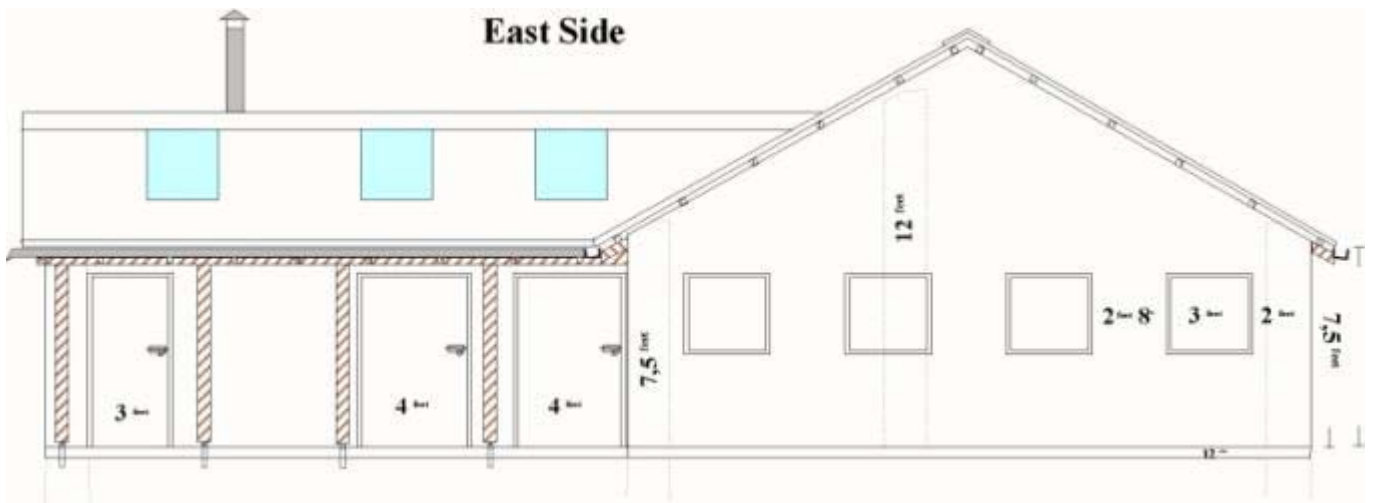

**Doors** shall be wider than in normal houses to give easy access for wheel chair, stretcher and moving in and out furniture. The Door Frames shall have **no bottom frame** to make easy access for wheel chair and to make cleaning more easily. Therefore anchors shall be prepared for the walls and iron bars to be fixed in the RCC before pouring concrete.

The Door Frames for Bedroom and Examination Room shall be 5 feet wide. For Delivery Room it shall be 4½ feet wide. For Toilet and Bathroom 4 feet wide. And for Kitchen only 3 feet wide. All Door Frames shall be 6½ feet high. And the door frames shall be without bottom frame to give unhindered access to the rooms, but instead they shall be fastened to the iron anchors which shall be poured in the concrete.

The **Wall** construction shall be well build, but only the stones at the corners shall be cut very nicely and brick shaped for durability and strength. To prepare the fixing of wall ceiling there shall be placed wooden battens in the wall construction. But remember giving enough space for water pipes. There shall be wires reaching up to support the roof beams. Those wires shall be well established deep in the wall.

**Water Pipes** shall be accessible for repair if they are leaking. But on the other hand, they shall not be left on the outside of the house for the frost to blow them. Therefore they shall be placed on the inner and bottom side of the walls. It shall be just above the rounded corners of the wall and can be under the wall ceiling or it can be just covered by the ceiling. Remember making space for the **flamingo foam tube** which shall cover the hot water pipe. Otherwise the hot water will cool down very soon after leaving the heater. It will be better making a groove in the lower part of the wall, than having the pipes being projecting into the room. And remember to make holes in the walls where the pipes shall lead through the walls.

The **35 mm water inlet pipe** shall enter the house on the back side and go all the way along the floor for the Water Heater in the Kitchen Stove. On the way T-connectors 35/20 mm shall lead off the **20 mm cold water pipes** for the taps.

The **20 mm hot water pipe** shall start at the Water Heater in the stove, but it shall also already now be prepared for connecting a Solar Heater later on.

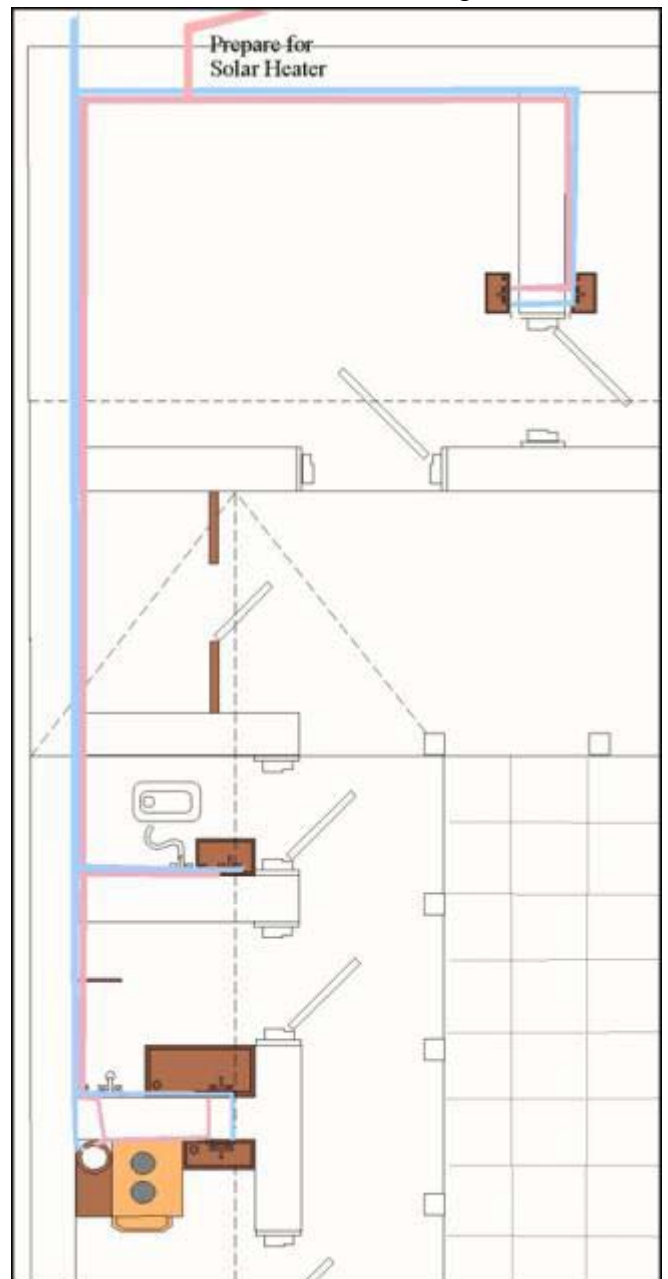



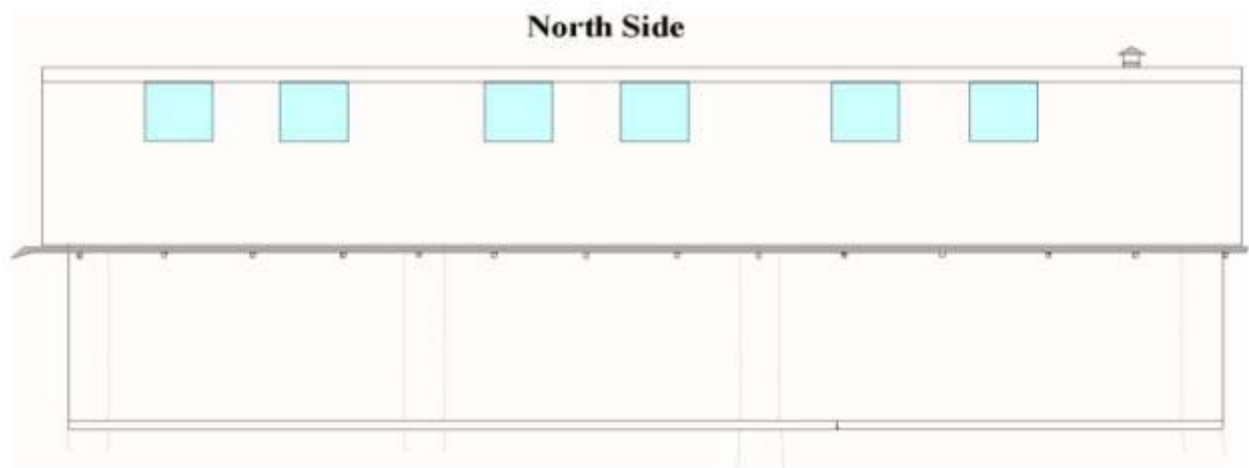
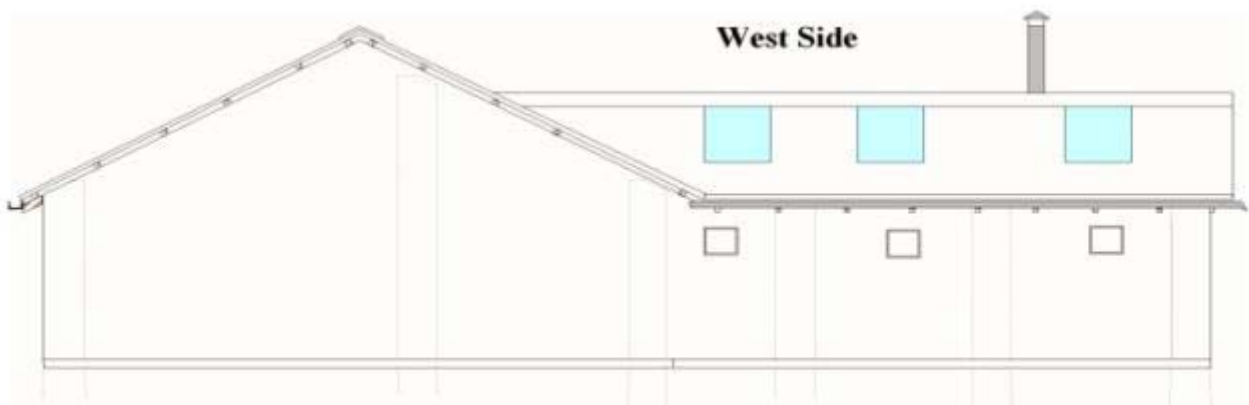
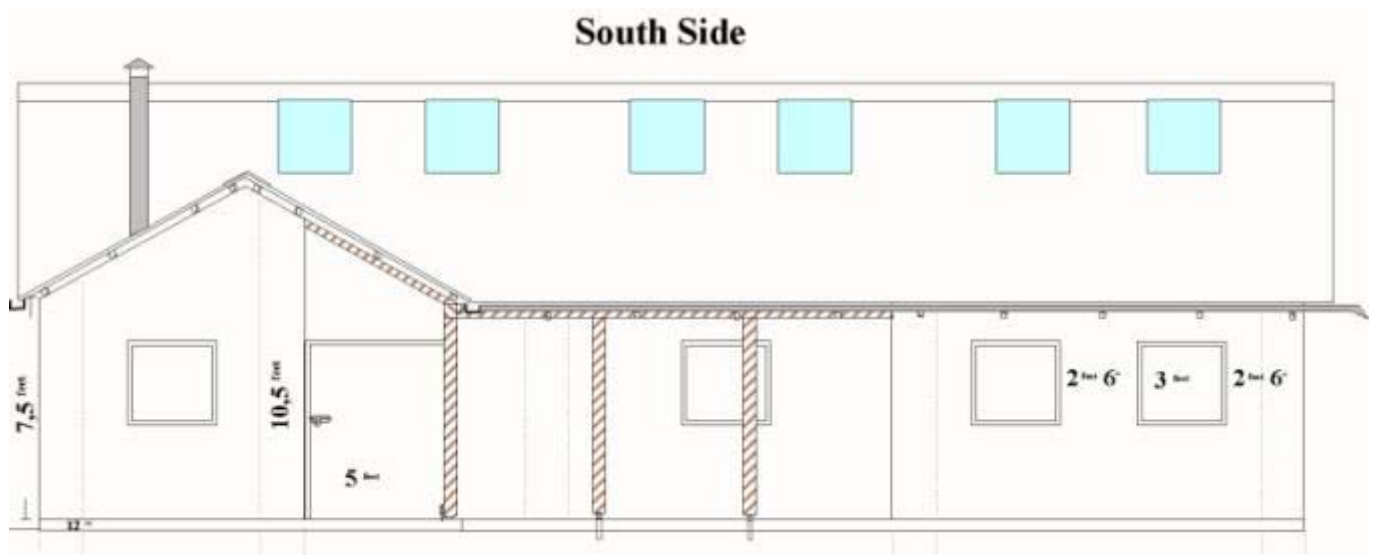

This shall be set up close to the big rock on the north side of the roof of the main building.

The connection to the water taps has to wait until the toilet and bathroom has been plastered and until wall ceiling has been set up. Or some fittings have to be prepared, which can take the wash basins out from the wall, and then the ceiling planks can be adjusted after. Metal plates can be produced from surplus of tin plates to set up above the wash basin to protect the wall against splashing.

The **Wash Basins** in kitchen, toilet, examination and delivery room shall be small and readymade to be purchased from outside. All **Water Taps** shall have regulators for both hot and cold water and be strong and good quality for durability. In Toilet there shall be an extra tap which can be connected to a soft plastic pipe for easy cleaning after toilet visit, especially for those who are suffering from diarre or other ailments in their back side.

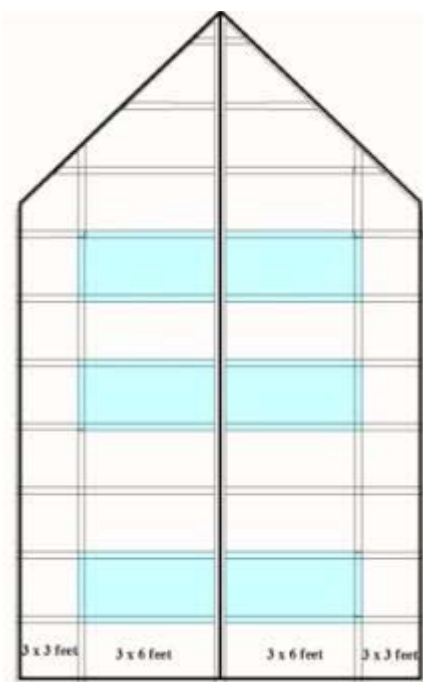
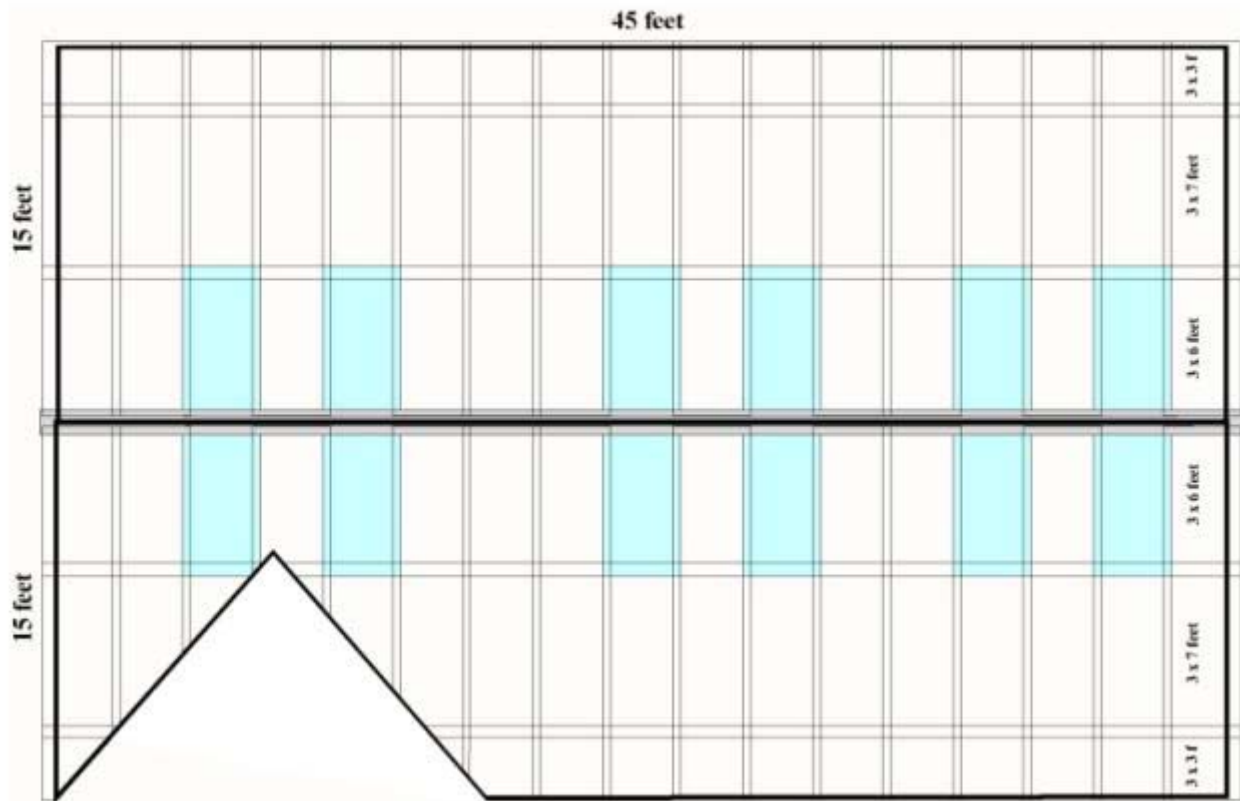

The **Roof** shall be build in a proper and strong way, and special attention shall be paid to preparing for the set up of a Solar Heater, so the roof will be strong enough to carry a heavy water drum.

The **Veranda Poles** shall be bolted to the Iron Anchors which is poured into the concrete. The poles shall NOT touch the floor, but be with 5 cm free space between floor and bottom of pole to prevent rot.

The **Tin Roof** and **Skylight Plates** shall be set up according to the sketch on following pages. Be aware that 3 different sizes shall be purchased: 3 x 3 feet & 3 x 6 feet & 3 x 7 feet.

There must be set up **Gutters** to lead the heavy rain in the monsoon out of the compound as too much water in the courtyard only can drain out by the compound wall and supportive wall and thus being able to weaken the high supportive wall. In the budget the cheap homemade gutter of tin-plates is mentioned, but if readymade plastic gutters is preferred it shall be done that way.

To protect the window glass and to protect the valuable interior **Iron Gratings** shall be produced and be set up on the outside of the windows.

The **Kitchen Stove** shall be produced in the traditional way. A readymade **Water Heater** shall be built into the stove and connected to the water pipes. The walls of the kitchen shall be plastered with mud (not cement). And a wooden funnel shall be built above the stove and connected to the **Chimney**.

A big **Wash Basin** shall be produced in Bathroom. It shall be big enough to settle a child for thorough washing and for washing of beddings. If a big readymade basin can be purchase it is also acceptable, but otherwise it shall be build on the spot by stoneslates, cement and iron enforcements.

A **500 liter Water Drum** shall be placed high above the building. It shall be connected to the water inlet of the house. And a plastic pipe shall be dug down and lead up to the nearest water source.

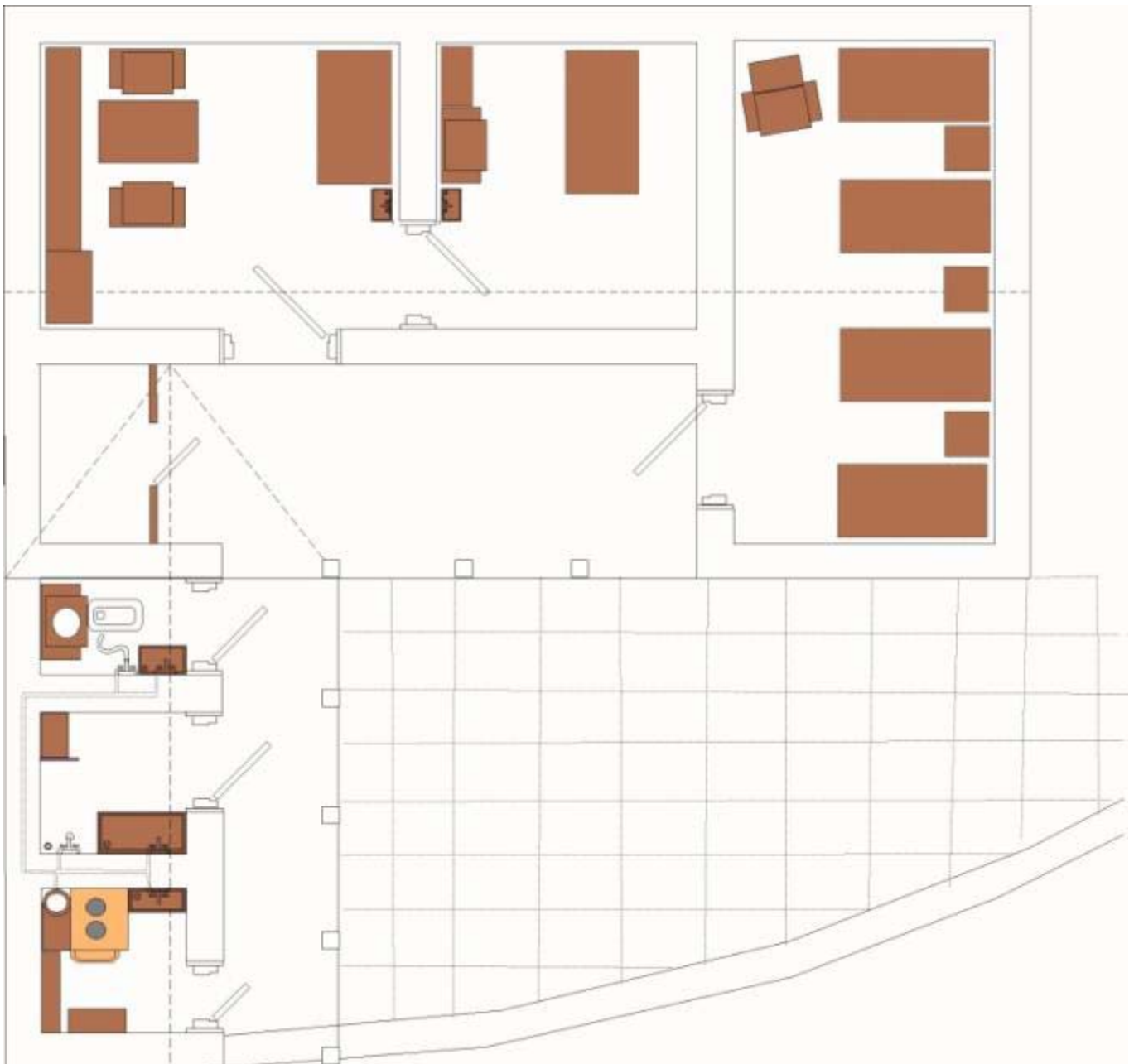

Electric wires, switches and a fuse box shall be set up and connected to the **Village Electricity**.

### **E. Furnishing the rooms:**

**Wooden Ceiling** can be set up when the water pipes have been fixed along the floor. The bricklayers hopefully did fix battens in the wall to fix the ceiling on; otherwise the ceiling will take up to much of the space in the rooms. Only the 3 rooms in the main building shall have ceiling. At the meeting in autumn it was suggested that the top ceiling should be rounded. In that case it shall be discussed with the carpenter when he put up roof beams. The ceiling leading up to the Skylight Plates shall be sloping to let as much light into the room as possible. Probably it will be the best and most easy to make, if the opening for skylight will cover both skylights and the in-between tin plate at the same time - covering the tin plate with simple roof ceiling.

A wooden wall and a simple wooden door shall be set up at the **Store Room** where wheelchair, broom, water buckets and other larger equipment shall be stored. And also a bench for undressing and dressing in the **Bathroom** also with a simple wooden wall which can protect the clothes against splashing when taking a shower. Remember discussing with cement layers, that they shall place the iron anchors on right spot before pouring the cement for floor.

Set up a bench and shelves in **Kitchen Room**. The shelves shall be for food items and kitchen equipment.

**4 Beds** for Bed Room shall be 3 x 6 feet and be of a very strong quality, so they can be moved out in the courtyard for cleaning every now and then when it is needed. Remember that they are for sick people.

At the head end it shall have a gable to lean against when sitting in the bed. At foot end and sides the frame shall be a little lower than the height of the mattress for more comfortable sitting on the sides of the bed.

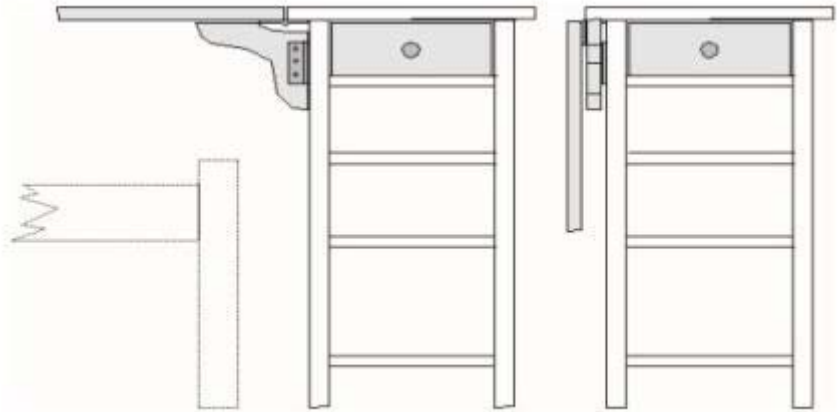

**3 Cupboards** at the beds with one drawer and several shelves. They shall be so high, that a folding table top can be turned up and reach a little in over the bed and the legs of the sick person for better access to eat and others. A strong wooden plate under the folding table top shall for that purpose with hinges be turned out to support the table top. Don't start this woodwork before the beds are completed, so the right height and functionality can be measured and the result can be tested on the spot.

The **Examination Couch** shall be 3 x 6 feet wide and long and the height a little less than 3 feet so the patient can be examined with a proper working posture of the examiner. The **Delivery Couch** shall have same dimensions. But wait to make those two pieces of furniture until we have checked the market for a readymade solution or proper mattresses.

A **Glass Cabinet** 2 feet deep and 3 feet wide with many shelves and 3 glass doors frames from top to bottom shall be build for Examination Room. And a **Cupboard** 1½ foot deep and approximately 8 feet wide (according to available space) with wooden doors in the upper part and just shelves in the lower part, which can be build in one piece or as two independent cupboards. They shall not be build-in the wall but be built as freestanding furniture, so they can be moved around according to practical needs. But of course they shall be fixed to the wall ceiling by fittings which can be loosened again.

For Delivery room there shall be a **Cupboard** 1½ foot deep and approximately 2½ foot wide (according to available space) with 3 doors from top to bottom, but only the upper door shall be with glass.

One **Doctors Table** with 3 Drawers shall be strong and well build 3 x 4 feet.

3 strong **Chairs** with Armrest shall be build.

One more **Chair** shall be build the same as above but with an Oval Hole in the seat 26 cm long and 21 cm wide. This hole shall be well and comfortably rounded on all edges. This chair shall be situated in

the toilet, for those diarre patients who are too weak to stay long at a normal pedal toilet.

And finally, probably never seen in Nepal before - or maybe even in the world - a homemade **Dentist Chair**. With this chair a dentist can work on both upper and lower row of teeth in a comfortable and efficient way. And when it is not in use by a visiting dentist it shall be placed in the bedroom, so it can be utilized as a sitting- sleeping- chair. It has to be very heavily and strong build so it can resist the forces working on it when the back is leaned backwards and the dentist is working with full force. The seat and back shall be connected by strong hinges. The position of the back shall be controlled by a strong

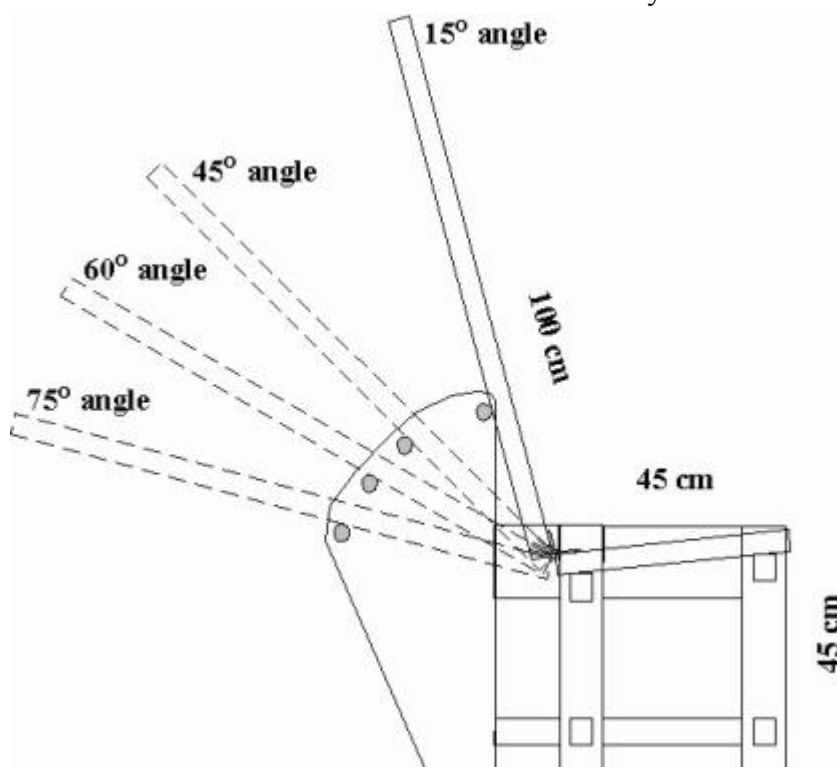

wooden stick which can be inserted in exact fitted holes in the massive back chair leg, so the back will be exactly positioned at 15° & 45° & 60° & 75°. To make sure that the stick will not fall out during operation, damaging the chair and the patient, the stick shall have a knob in the one end, which can't pass through the hole, and a small hole in the other end where a nail can be put in.

## **F. Compound Wall and extras:**

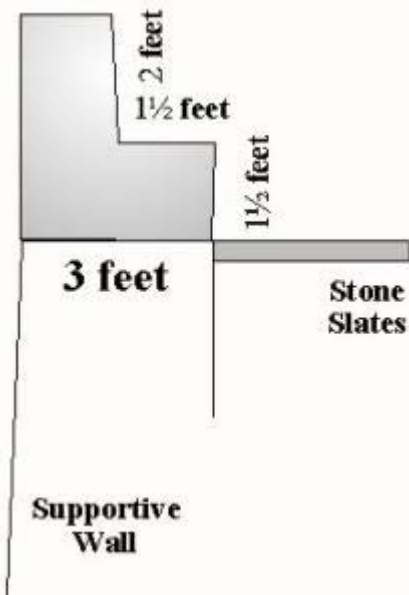

Then final finish to make the whole compound attractive and giving the users the impression that this is something special. The facility shall also be used for meetings when professionals will come to inform about health and prevention. Therefore the compound wall shall besides of keeping animals out also have the function as a seat. The supportive wall on the south side which were constructed already in the beginning shall be 3 feet wide in the top. The compound wall build on top of this shall be same width in bottom up to 1 1/2 feet height. The following wall shall only have 1 1/2 feet in width, producing a seat 1 1/2 feet wide.

Closer to the gate the wall shall be higher to keep cows out and therefore it can be less heavily build and the seat can be dropped. On the north side of the gate there shall be no seat and the wall shall have the height necessary to keep animals out.

Where the supportive wall ends, the compound wall shall have a 3 feet deep fundament.

The gate shall be nicely built but not necessarily too impressive. There shall be a lockable door in the gate.

When the wall and gate is build the stone layer can complete the stone slate covering. This shall continue on the access road until the road starts climbing down.

## **G. Administration and Monitoring:**

Himalayan Project and Himalayan Project Nepal (HIPRON) have already visited Chhiringkharka several times to discuss the project and we will continue every now and then during the construction phase to visit the place to monitor the project and to give advice. Every 3 months a report will be produced for donor as a result of the visits, and by end of the project there will be delivered a Project Report showing the result. For several years ahead we will continue being in contact with the clinic even though the project is actually completed.

For this work Himalayan Project charges 15% of the total Project Budget, which shall be paid to HP with the first installment.

The transfer of funds for establishing the clinic will be divided into two installments. The first to get properly started, and the second when all the preliminary work and accounting has been approved.

## **H. Supply Phase:**

When the construction process is completed it will be a part of the project to deliver all necessary equipment to get started in a proper way. When the clinic is set up it can be expected that some supplementary wishes and demands will show up, and it will be our hope that the Donor will be ready to go into this final completion when the budget will be shown.

## **I. Education Phase:**

Also the education of the Staff at the clinic will be part of this project, but we can expect support from other sides for this part.

A group of volunteers from Chhiringkharka shall take training at Phaplu Hospital to achieve basic knowledge about First Aid, various techniques in examining a patient, dressing wounds, injection and other skills, having some knowledge about common diseases and whatever they can experience in a hospital within 1-2 months. This plan was discussed with District Health Officer Mr. Bawan Jang Raya Maji and he was ready to support this as soon as we have the approval from his office to run this project.

1-2 married women from Chhiringkharka shall have 18 months training in Kathmandu for Auxillary Nurse Midwife who later can be in charge of the clinic. This has been discussed with Rotary Club of Kathmandu, who supports this education and demands a contract from the participants that they will utilize their education in the home village. The cost for this education is 140.000 Rs/person including study fee, fooding and lodging. The rotary club supports this with 50% and are upon that even adding a fund for microloan administered by the ANM.

Himalayan Project is preparing a project which shall empower women in Bakanje VDC. A part of this project will be conducting theoretical and practical knowledge about health, prevention and nutrition among villagers, also in Chhiringkharka. That project will be run independently from this Project.

**This “Construction Description” has been examined and discussed scrupulously in the Construction Committee and with future Contractors, and it is approved by all Construction Committee 5 Members and all Monitoring Committee 5 Members**

**in Chhiringkharka on Date : \_\_\_\_\_**

\_\_\_\_\_  
Kami Chhiri Sherpa  
Chairman of Construction Committee

\_\_\_\_\_  
Furi Sherpa  
Accountant of Construction Committee

\_\_\_\_\_  
Kaji Man Thami  
Member of Construction Committee

\_\_\_\_\_  
Kha Shi Thami  
Member of Construction Committee

\_\_\_\_\_  
Gora Tamang  
Member of Construction Committee

\_\_\_\_\_  
Lhakpa Lama  
Chairman of Monitoring Committee

\_\_\_\_\_  
Da Sarki Sherpa  
Member of Monitoring Committee

\_\_\_\_\_  
Dawa Lama  
Member of Monitoring Committee

\_\_\_\_\_  
Mingma Dorje Lama  
Member of Monitoring Committee

\_\_\_\_\_  
Ang Mingma Sherpa  
Member of Monitoring Committee

To  
The Manager  
Himalayan Project Nepal  
Lazimpat-2, Kathmandu Nepal

Sub: Report of the Health Post

There was discussion about Chhiringkharka Sub-Health Post Regarding the land and Construction Committee.

They have chosen New Location for the Construction as previous land Donor doesn't want to donate his land. New land belongs to Da Sarki Sherpa, which is located just below north to the previous location.

They formed following Committee for the Construction and also discussed the project proposal thoroughly, they considered that the budget on wood and Stone is little less. Cost of Wood and Stone cutting and transportation has risen up and following amount is Inadequate in the Project Proposal. Construction Committee would like to propose you to add inadequate amount in project proposal Budget.

### **Construction Committee**

| S. No | Name               | Address   |
|-------|--------------------|-----------|
| 1     | Kami Chhiri Sherpa | Bakanje-2 |
| 2     | Furi Sherpa        | Bakanje-2 |
| 3     | KajiMan Thami      | Bakanje-1 |
| 4     | Kha Shi thami      | Bakanje-1 |
| 5     | Gora Tamang        | Bakanje-2 |

### **Monitoring Committee**

| S. No | Name              | Address   |
|-------|-------------------|-----------|
| 1.    | Lhakpa Lama       | Bakanje-2 |
| 2.    | Da Sarki Sherpa   | Bakanje-1 |
| 3.    | Dawa Lama         | Bakanje-2 |
| 4.    | Migma Dorje Lama  | Nakanje-2 |
| 5.    | Ang Mingma Sherpa | Nakanje-1 |

**1 Wood Cutting and Transportation**  
**2 Stone**

**12000**

**13000**